

# KOMATSU®

## HORSEPOWER

Gross: 514 kW 688 HP / 1800 min<sup>-1</sup>

Net: 502 kW 672 HP / 1800 min<sup>-1</sup>

## OPERATING WEIGHT

Backhoe: 106500–110700 kg

234,790–244,050 lb

Loading shovel: 110900 kg

244,490 lb

## PC1250/1250SP-8R BACKHOE PC1250-8R LOADING SHOVEL

PC  
1250



Photo may include optional equipment.

HYDRAULIC EXCAVATOR

# WALK-AROUND

## Productivity Features

- **Heavy Lift Mode**  
The heavy lift mode increases lifting force by 10%.
- **Large Digging Force**  
High operation efficiency with large digging force for severe applications.
- **Two-mode Setting for Boom**  
Switch selection allows either powerful digging or smooth boom operation.
- **Twin Swing Motor System** provides excellent swing performance, even on slopes.
- **Large Drawbar Pull and Steering Force** provide excellent mobility.
- **Swing Priority Mode**  
The swing priority mode improves efficiency for loading dump trucks at 90° or 180°.
- **Shockless Boom**  
Switch selection reduces chassis vibration after sudden stops.

See page 5.

## Excellent Reliability and Durability

- **Strengthened Quarry Bucket Provided Outstanding Wear-resistance (optional)**
- **XS Bucket Teeth** offers superior penetration and long-term sharpness.
- The fuel reliability is improved by installing **2 Fuel Main-Filters and Water Separator** working against low grade fuel.
- **Fuel Pre-filter** with water separator equipped as standard.
- **O-ring Face Seals**, which have excellent sealing performance, are used for the hydraulic hoses.
- **High-pressure In-line Filtration**  
The cool-running hydraulic system is protected with the most extensive filtration system available, including a high pressure in-line filter for each main pump.



## Easy Maintenance

- **Easy Cleaning of Cooling Unit**  
Fan reverse-rotation function facilitates clogged radiator cleaning.
- **Centralized Arrangement of Engine Checkpoints**
- **Anti-slip Plates** for improved foot traction
- **Large Handrail, Step and Catwalk** provide easy access to the engine and hydraulic equipment.
- **Electric Priming Pump** installed.

See page 10.

- **Highly Reliable Electronic Devices**  
Exclusively designed electronic devices have passed severe testing.
  - Controllers • Sensors • Connectors
  - Heat resistant wiring • Circuit breaker
- **Boom Foot Hoses** are arranged under the boom foot, improving hose life and safety.

See pages 6, 7.

## Ecology and Economy Features

- **High Power Komatsu SAA6D170E-5 Engine**
  - Powerful turbocharged and air-to-air aftercooled Komatsu SAA6D170E-5 engine provides **502 kW** 672 HP.
  - Offers high power and low fuel consumption.
  - Equipped with electronically controlled variable speed fan.
- **Economy Mode Four-level Setting**
  - Enables operator to select the appropriate Economy mode level to match production requirement with lowest fuel consumption.
- **Reduction of Ambient Noise**
  - Electronically controlled variable speed fan drive
  - Large hybrid fan

See page 4.

**HORSEPOWER**  
 Gross: 514 kW 688 HP / 1800 min<sup>-1</sup>  
 Net: 502 kW 672 HP / 1800 min<sup>-1</sup>

**OPERATING WEIGHT**  
**Backhoe**  
 106500 – 110700 kg  
 234,790 – 240,050 lb  
**Loading shovel**  
 110900 kg  
 244,490 lb



Photo may include optional equipment.

## Working Environment

- **Large Comfortable Cab**
  - Low noise and vibration with cab damper mounting
  - Large-capacity air conditioner (optional)
  - Pressurized cab prevents external dust from entering
  - OPG top guard level 2 (by ISO 10262 standard) capable with optional bolt-on top guard.

See pages 8, 9.



## Advanced Monitor Features

- Machine condition can be checked with Equipment Management Monitoring System (EMMS). See page 11.
- Two working modes combine with heavy lift mode for maximum productivity.

See page 5.

# PRODUCTIVITY & ECOLOGY FEATURES

## Komatsu Technology

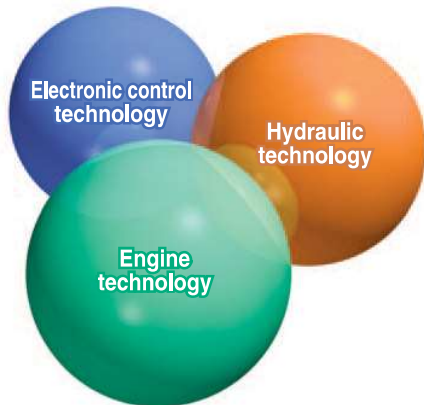

Komatsu develops and produces all major components, such as engines, electronics and hydraulic components, in house. With this “Komatsu Technology,” and adding customer feedback, Komatsu is achieving great advancements in technology. To achieve both high levels of productivity and economical performance, Komatsu has developed the main components with a total control system. The result is a new generation of high performance and environment friendly excavators.

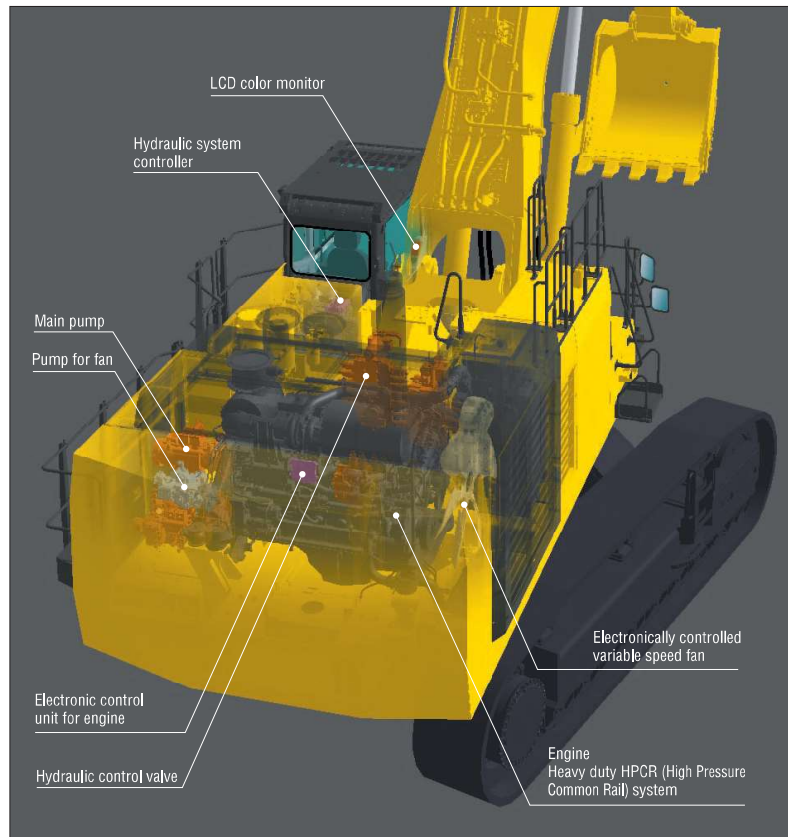

### High Power Komatsu SAA6D170E Engine

Powerful turbocharged and air-to-air aftercooled Komatsu SAA6D170E-5 engine provides **502 kW** 672 HP. This Komatsu SAA6D170E engine actualizes high-power to low fuel consumption with the optimum fuel injection by electronic heavy duty HPCR (High Pressure Common Rail) fuel injection system.

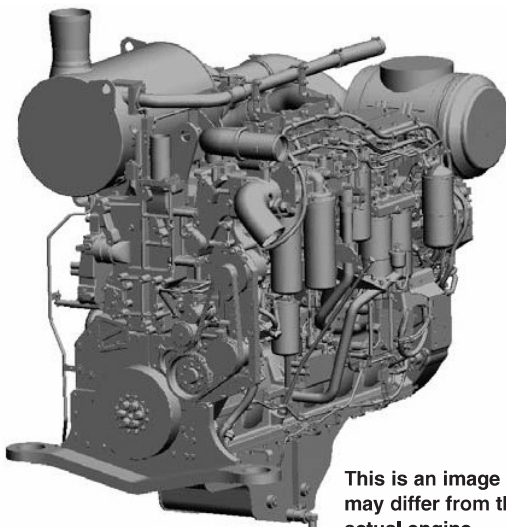

This is an image photo: may differ from the actual engine.

### Electronically Controlled Variable Speed Fan Contributes to Low Fuel Consumption and Low Noise

The electronic control system sets the rotational speed of the cooling fan according to the coolant and hydraulic oil temperature; effectively uses the engine output to prevent wasteful fuel consumption; and reduces noise during low-speed fan rotation.



### Lower and Economical Fuel Consumption Using Economy Mode

Enables operator to set the Eco mode to up to four levels according to working conditions so that production requirement is achieved at lowest possible fuel consumption.

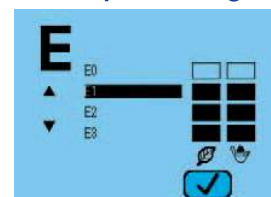

### Reduction of Ambient Noise

Reduced noise by adoption of an electronically controlled variable speed fan drive, large hybrid fan, low-noise muffler.

**Large Digging Force**

Thanks to the high engine output and an excellent hydraulic system, this machine demonstrates powerful digging force.

**Maximum arm crowd force (ISO):**  
**412 kN 42.0 ton**

**Maximum bucket digging force (ISO):**  
**479 kN 48.8 ton**

**Large Drawbar Pull and Steering Force**

Since the machine has a large drawbar pull and a high steering force, it demonstrates excellent mobility even when it is being used on inclined sites.

**Two-mode Setting for Boom**

**Smooth mode** provides easy operation for gathering blasted rock and scraping operations. When maximum digging force is needed, switch to **power mode** for more effective excavating.

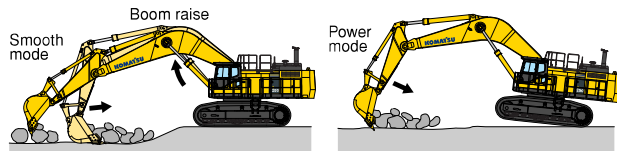

**Shockless Boom Control**

The PC1250-8R boom circuit features a shockless valve (double-check slow return valve) to automatically reduces the amount of vibration present when operating the boom. Operator fatigue is reduced (which can improve safety and productivity), and spillage caused by vibration is minimized.

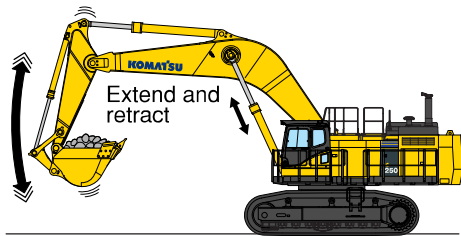

**Working Mode Selection**

**Power and Economy Mode**

The PC1250-8R excavator is equipped with two working modes. Each mode is designed to match engine speed, pump flow, and system pressure to the current application, giving the operator flexibility to match equipment performance to the job at hand.

Working Mode	Application	Advantage
P	Power Mode	<ul style="list-style-type: none"> <li>• Maximum production/power</li> <li>• Fast cycle time</li> </ul>
E (E0,E1,E2,E3)	Economy Mode	<ul style="list-style-type: none"> <li>• Good cycle time</li> <li>• Good fuel economy</li> </ul>

**Heavy Lift Mode**

Gives the operator 10% more lifting force on the boom when needed for handling rock or heavy lifting applications.

**Swing Priority Setting**

The swing priority setting allows the operator to use the same easy motion for 180° loading as 90° loading operations. By altering the oil flow, this setting allows you to select either boom or swing as the priority for increased production.

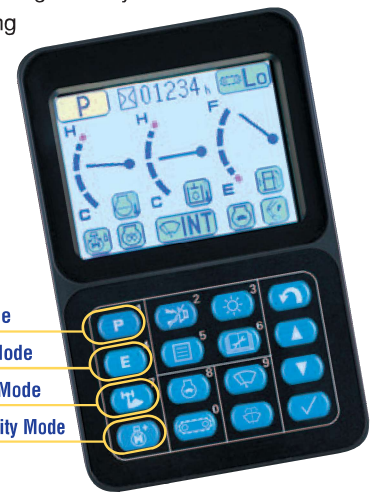

# RELIABILITY FEATURES

## Excellent Reliability and Durability

### Boom Foot Hoses

The boom foot hoses are arranged under the boom foot to reduce hose bend during operation, extending hose life and improving operator safety.



### Strengthened Boom and Arm

Thanks to the large cross-sectional structure employing a high tensile strength steel with a thick plate, partition wall, etc., the boom and arm exhibit excellent durability and are highly resistant to bending and torsional stress.

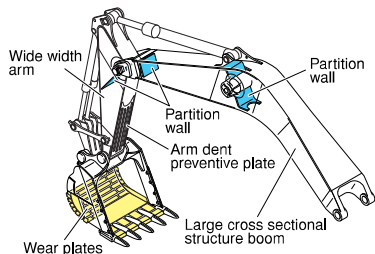

### O-ring Face Seal

The hydraulic hose seal method has been changed from a conventional taper seal to an O-ring seal. This provides improved sealing performance during operation.

### Circuit Breaker

With circuit breaker, the machine can be easily restarted after repair.



### High-pressure In-line Filtration

The PC1250-8R has the most extensive filtration system available, providing in-line filters as standard equipment. An in-line filter in the outlet port of each main hydraulic pump reduces failures caused by contamination.



### Metal Guard Rings

Metal guard rings protect all the hydraulic cylinders and improve reliability.

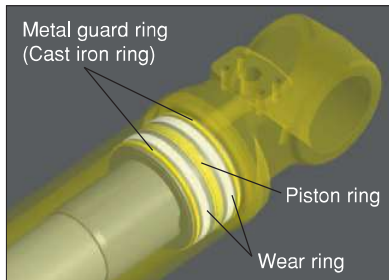

### Heat-resistant Wiring

Heat-resistant wiring is utilized for the engine electric circuit and other major component circuit.

### Additional Water Separator

Removes water from the fuel and improves the reliability of fuel systems.



### Sturdy Undercarriage

The undercarriage is strengthened to provide excellent reliability and durability when working on rocky ground or blasted rock.



Sturdy guards shield the travel motors and piping against damage from rocks.



Track roller guard (full length) (optional)

### Fuel Pre-filter (with Water Separator)

Removes water and contaminants from fuel to enhance the fuel system reliability.

### Fuel Main-filters

The reliability of fuel systems is improved, because fuel main-filters installed remove contamination and sludge contained in fuel.



Fuel pre-filter (with water separator)  
Fuel main-filter Additional fuel main-filter

**Strengthened Quarry Bucket Provided Outstanding Wear-resistance (optional)**

The bucket for specific use in quarry is impact and wear resistant, providing high performance and long life.

Koma-hard materials\* provide excellent wear resistance. Combined with adoption of long-life XS teeth, durability of bucket is drastically enhanced.

\* Koma-hard materials (KVX materials):  
 Komatsu developed, wear-resistant, reinforced materials.  
 Brinell hardness: 500 or more (180kgf/mm<sup>2</sup> class).  
 Features high wear-resistance and little quality change from the heat generated during rock loading, maintaining long term hardness.

**XS Tooth**

- Unique bucket tooth shape, superior digging performance
- Long-term high sharpness
- Great penetration performance
- Hammerless, safe, and easy tooth replacement  
 (Tooth replacement time: Halves the conventional machine.)

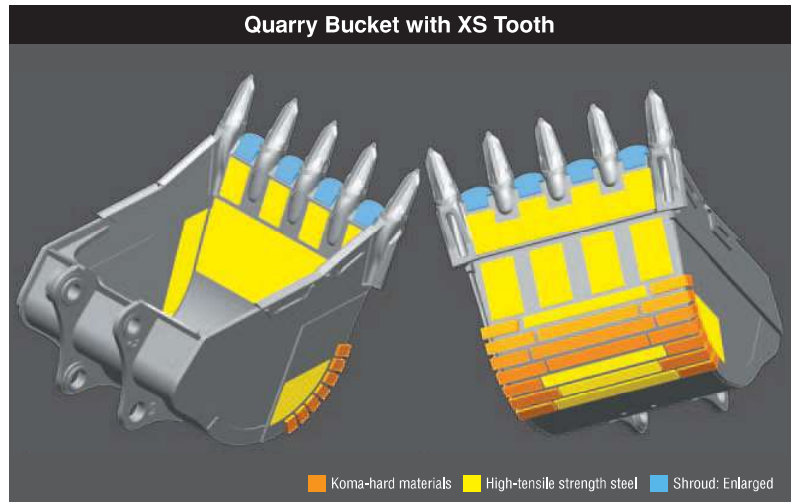

**STEP 1**

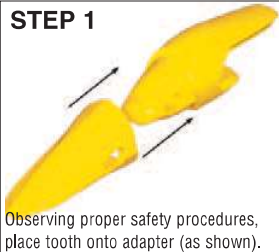

Observing proper safety procedures, place tooth onto adapter (as shown).

**STEP 2**



Insert fastener, making sure it is in the unlocked position (as shown).

**STEP 3**

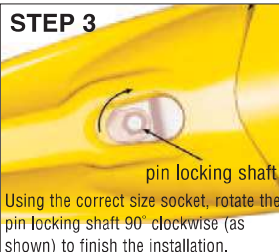

Using the correct size socket, rotate the pin locking shaft 90° clockwise (as shown) to finish the installation.

**STEP 4**



To remove fastener, use the correct size socket to rotate the pin locking shaft 90° counter-clockwise (as shown). Remove fastener and tooth. Repeat steps 1-3 for a new installation.



# WORKING ENVIRONMENT

*The cab interior is spacious and provides a comfortable working environment...*

## Large Comfortable Cab

### Comfortable Cab

New PC1250-8R's cab offers an exceptionally comfortable operating environment. The large cab enables full flat reclining of the seat back with headrest.

### Pressurized Cab

The optional air conditioner, air filter and a higher internal air pressure (6.0 mm Aq 0.2" in Aq) prevent external dust from entering the cab.

### Low Noise Design

Noise level is remarkably reduced, not only engine noise but also swing and hydraulic relief noise.

### Low Vibration with Cab Damper Mounting

PC1250-8R uses a new, improved cab damper mount system that incorporates longer stroke and the addition of a spring.

The new cab damper mounting combined with a strengthened left and right side deck, aids vibration reduction at the operator's seat.

Vibration at floor is reduced from 120 dB (VL) to 115 dB (VL).

dB (VL) is index for expressing size of vibration.

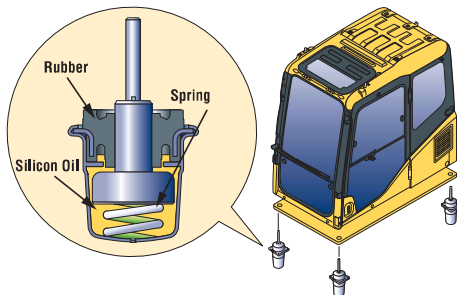

### Comparison of Riding Comfort

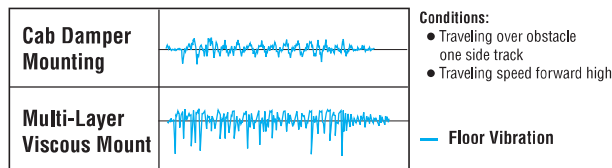

Vertical direction on graph shows size of vibration.



Photo may include optional equipment.

### Automatic Air Conditioner (optional)

A 6,900 kcal air conditioner is utilized. The bi-level control function keeps the operator's head and feet cool and warm respectively. This improved air flow function keeps the inside of the cab comfortable throughout the year.

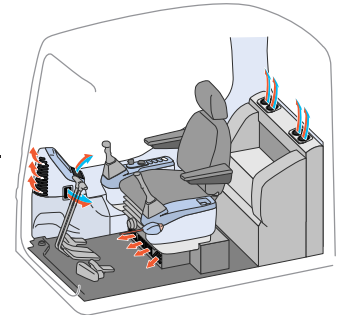

### Washable Cab Floor Mat

The PC1250-8R's cab floor mat is easy to keep clean. The gently inclined surface has a flanged floor mat and drainage holes to facilitate runoff.



## Safety Features

### Step Light with Timer

provides light for about one minute to allow the operator to get off the machine safely.



### Pump/engine Room Partition

prevents oil from spraying on the engine if a hydraulic hose should burst.

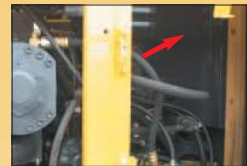

**Thermal and Fan Guards** are placed around high-temperature parts of the engine and fan drive.

### Slip-resistant Plates

Spiked plates on working surfaces provide slip-resistant performance.



*Slip-resistant Plates*

### Horn Interconnected with Warning Light (optional)

gives visual and audible notice of the excavator's operation when activated.



*Seat with headrest reclined full flat*

*Photo may include optional equipment.*

### Multi-position Controls

The multi-position, PPC (proportional pressure control) levers allow the operator to work in comfort while maintaining precise control. A double-slide mechanism allows the seat and control levers to move together or independently, allowing the operator to position the controls for maximum productivity and comfort.



*Seat Sliding Amount: 340 mm 13.4", increased 120 mm 4.7"*



*Defroster (optional)*



*Cab Frame Mounted Wiper*



*Bottle Holder and Magazine Rack*

# EASY MAINTENANCE FEATURES

## *Komatsu Designed the PC1250-8R for Easy Service Access.*

### Easy Checking and Maintenance

Wide center walkway provides easy access to many inspection and maintenance points. In addition, inspection and maintenance points are grouped to facilitate easy engine and hydraulic component checks.

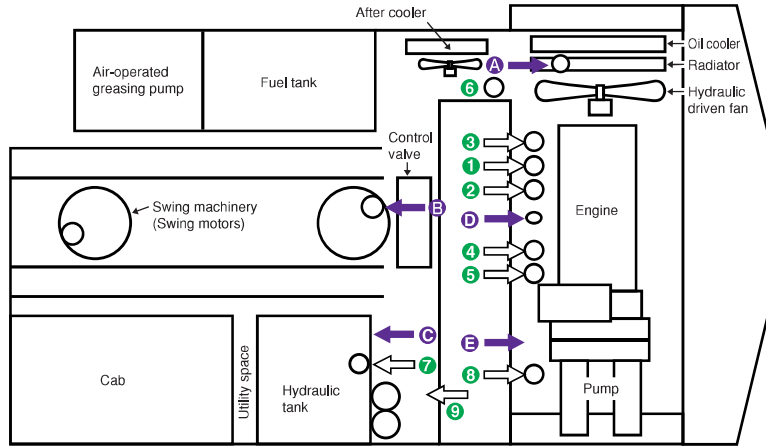

- |                          |                                      |                                     |
|--------------------------|--------------------------------------|-------------------------------------|
| <b>A</b> Coolant         | <b>1</b> Corrosion resister          | <b>6</b> Additional water-separator |
| <b>B</b> Swing machinery | <b>2</b> Fuel main-filter            | <b>7</b> Hydraulic drain filter     |
| <b>C</b> Hydraulic tank  | <b>3</b> Engine oil filter           | <b>8</b> Pilot filter               |
| <b>D</b> Engine oil      | <b>4</b> Fuel pre-filter             | <b>9</b> Return filter              |
| <b>E</b> PTO case        | <b>5</b> Additional fuel main-filter |                                     |

### Wide Catwalk, Large Step and Handrails

Easier, safer operator cab access and maintenance checks.



### Easy Cleaning of Radiator

The hydraulically driven fan can be reversed to facilitate cleaning of the cooling unit.



### Reduced Maintenance Costs

High performance filters are used in the hydraulic circuit and engine. Longer hydraulic oil, hydraulic oil filter, engine oil and engine oil filter element replacement intervals significantly reduce maintenance costs.



### Dust Indicator with 5-step Indication

Informs of air clean clogging in 5 steps to warn of filter condition.



### Convenient Utility Space

Utility space provides great convenience to store tools, spare parts, etc.



### Electric Priming Pump

Bleeding air from fuel system is easily accomplished with the electric priming pump.

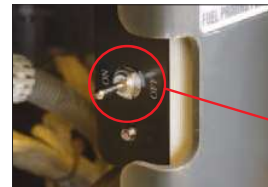

Electric priming pump switch

**High-Quality EMMS Self-diagnostic System**

**• Abnormality checking function**

If any abnormality should occur, the monitoring system checks whether hydraulic pressures, solenoid ON/OFF status, engine speed, electrical connections, etc. are within normal condition to keep machine downtime to a minimum.

**• Maintenance history memory function**

Maintenance records such as replacement of engine oil, hydraulic oil, filters, etc. can be stored. Operator is warned when service is due.

**• Trouble data memory function**

Trouble data is stored to serve as references for future trouble-shooting. Error codes are displayed to aid in service diagnosis.

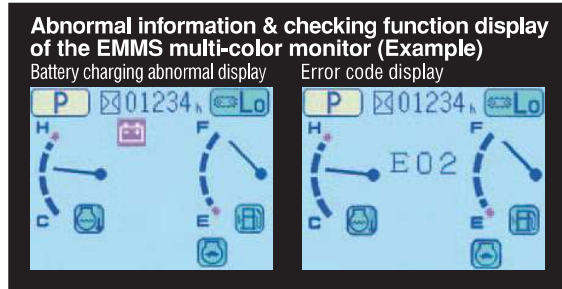
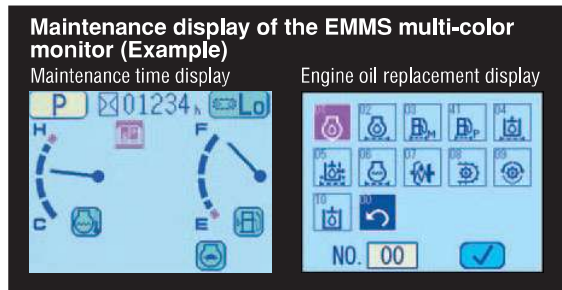

**VHMS (Vehicle Health Monitoring System) (optional)**

VHMS controller monitors the health conditions of major components and enables remote analysis of the machine and its operation. This contributes to reduced repair costs and to maintaining maximum availability.

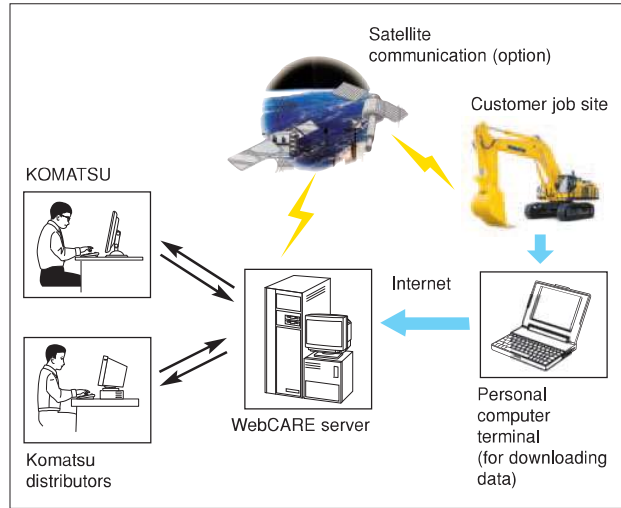

Photo may include optional equipment.

# SPECIFICATIONS



## ENGINE

Model . . . . . Komatsu SAA6D170E-5  
 Type . . . . . 4-cycle, water-cooled, direct injection  
 Aspiration . . . . . Turbocharged, aftercooled  
 Number of cylinders . . . . . 6  
 Bore . . . . . **170 mm** 6.69"  
 Stroke . . . . . **170 mm** 6.69"  
 Piston displacement . . . . . **23.15 ltr** 1413 in<sup>3</sup>  
 Governor . . . . . All-speed, electronic  
 Horsepower:  
   SAE J1995 . . . . . Gross **514 kW** 688 HP  
   ISO 9249 / SAE J1349\* . . . . . Net **502 kW** 672 HP  
 Rated rpm . . . . . 1800 min<sup>-1</sup>  
 Fan drive type . . . . . Hydraulic

\*Net horsepower at the maximum speed of radiator cooling fan is **463 kW** 620HP.



## HYDRAULIC SYSTEM

Type . . . . . Open-center load-sensing system  
 Number of selectable working modes . . . . . 2

### Main pump:

Type . . . . . Variable-capacity piston pumps  
 Pumps for . . . . . Boom, arm, bucket, swing, and travel circuits

### Maximum flow:

For implement and travel . . . **2 x 494 ltr/min** 2 x 130.5 U.S. gpm  
 For swing . . . . . **1 x 600 ltr/min** 1 x 158.5 U.S. gpm

Sub-pump for control circuit . . . . . Gear pump

### Hydraulic motors:

Travel . . . . . 2 x axial piston motors with parking brake  
 Swing . . . . . 2 x axial piston motors with swing holding brake

### Relief valve setting:

#### Implement circuits

Backhoe . . . . .	<b>31.4 MPa</b>	320 kgf/cm <sup>2</sup>	4,550 psi
Loading shovel . . . . .	<b>31.4 MPa</b>	320 kgf/cm <sup>2</sup>	4,550 psi
Travel circuit . . . . .	<b>34.3 MPa</b>	350 kgf/cm <sup>2</sup>	4,980 psi
Swing circuit . . . . .	<b>27.4 MPa</b>	280 kgf/cm <sup>2</sup>	3,980 psi
Pilot circuit . . . . .	<b>2.9 MPa</b>	30 kgf/cm <sup>2</sup>	430 psi

### Hydraulic cylinders:

Number of cylinders—bore x stroke

#### Backhoe

Boom . . . . .	<b>2 – 225 mm x 2390 mm</b>	8.9" x 94.1"
Arm . . . . .	<b>1 – 250 mm x 2435 mm</b>	9.8" x 95.9"
Bucket		
Std . . . . .	<b>2 – 160 mm x 1825 mm</b>	6.3" x 71.8"
SP . . . . .	<b>2 – 160 mm x 1950 mm</b>	6.3" x 76.8"

#### Loading shovel

Boom . . . . .	<b>2 – 225 mm x 1960 mm</b>	8.9" x 77.2"
Arm . . . . .	<b>2 – 185 mm x 1765 mm</b>	7.3" x 69.5"
Bucket . . . . .	<b>2 – 200 mm x 1700 mm</b>	7.9" x 66.9"
Bottom dump . . . . .	<b>2 – 160 mm x 435 mm</b>	6.3" x 17.1"



## SWING SYSTEM

Driven by . . . . . Hydraulic motors  
 Swing reduction . . . . . Planetary gear  
 Swing circle lubrication . . . . . Grease-bathed  
 Swing lock . . . . . Oil disc brake  
 Swing speed . . . . . 5.8 min<sup>-1</sup>



## DRIVES AND BRAKES

Steering control . . . . . Two levers with pedals  
 Drive method . . . . . Fully hydrostatic  
 Travel motor . . . . . Axial piston motor, in-shoe design  
 Reduction system . . . . . Planetary double reduction  
 Maximum drawbar pull . . . . . **686 kN** 70000 kgf 154,320 lb  
 Gradeability . . . . . 70%  
 Maximum travel speed  
   Low . . . . . **2.1 km/h** 1.3 mph  
   High . . . . . **3.2 km/h** 2.0 mph  
 Service brake . . . . . Hydraulic lock



## UNDERCARRIAGE

Center frame . . . . . H-leg frame  
 Track frame . . . . . Box-section  
 Seal of track . . . . . Sealed  
 Track adjuster . . . . . Hydraulic  
 No. of shoes . . . . . 48 each side  
 No. of carrier rollers . . . . . 3 each side  
 No. of track rollers . . . . . 8 each side



## COOLANT AND LUBRICANT CAPACITY (REFILLING)

Fuel tank . . . . .	<b>1360 ltr</b>	359.3 U.S. gal
Radiator . . . . .	<b>142 ltr</b>	37.5 U.S. gal
Engine . . . . .	<b>86 ltr</b>	22.7 U.S. gal
Final drive, each side . . . . .	<b>21 ltr</b>	5.5 U.S. gal
Swing drive . . . . .	<b>20.0 x 2 ltr</b>	5.3 x 2 U.S. gal
Hydraulic tank . . . . .	<b>670 ltr</b>	177.0 U.S. gal
PTO . . . . .	<b>13.5 ltr</b>	3.7 U.S. gal



## OPERATING WEIGHT (APPROXIMATE)

### BACKHOE

PC1250-8R: Operating weight, including **9100 mm** 29'10" boom, **3400 mm** 11'2" arm, SAE heaped **5.0 m<sup>3</sup>** 6.5 yd<sup>3</sup> backhoe bucket, operator, lubricant, coolant, full fuel tank, and the standard equipment.

PC1250SP-8R: Operating weight, including **7800 mm** 25'7" boom, **3400 mm** 11'2" arm, SAE heaped **6.7 m<sup>3</sup>** 8.8 yd<sup>3</sup> backhoe bucket, full length roller guard, operator, lubricant, coolant, full fuel tank, and the standard equipment.

Shoes	PC1250-8R		PC1250SP-8R	
	Operating Weight	Ground Pressure	Operating Weight	Ground Pressure
Double grouser 700 mm 28"	<b>106500 kg</b> 234,790 lb	<b>136 kPa</b> 1.39 kgf/cm <sup>2</sup> 19.8 psi	<b>110700 kg</b> 244,050 lb	<b>141 kPa</b> 1.44 kgf/cm <sup>2</sup> 20.4 psi
Double grouser 1000 mm 39.4"	<b>108810 kg</b> 239,880 lb	<b>97 kPa</b> 0.99 kgf/cm <sup>2</sup> 14.1 psi	–	–

### LOADING SHOVEL

Operating weight, including **5300 mm** 17'5" boom, **3800 mm** 12'6" arm, **6.5 m<sup>3</sup>** 8.5 yd<sup>3</sup> heaped bucket, operator, lubricants, coolant, full fuel tank and standard equipment.

Shoes	PC1250-8R	
	Operating Weight	Ground Pressure
Double grouser 700 mm 28"	<b>110900 kg</b> 244,490 lb	<b>142 kPa</b> 1.45 kg/cm <sup>2</sup> 20.6 psi



## BACKHOE DIMENSIONS

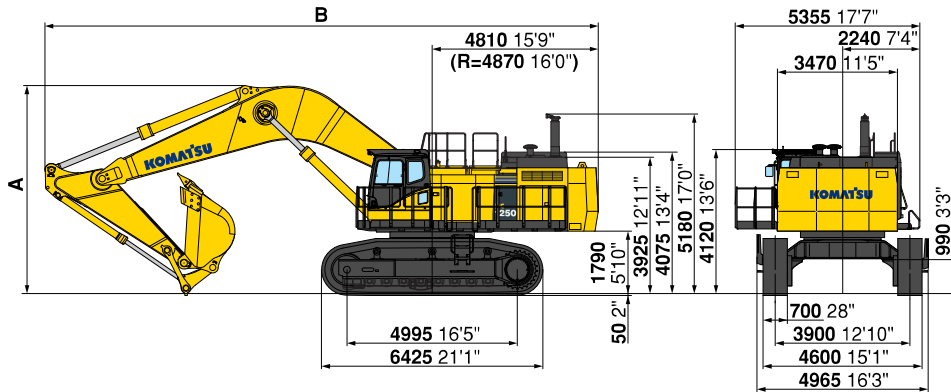

	PC1250-8R			PC1250SP-8R
	9.1 m 29'10" boom			
	3.4 m 11'2" arm	4.5 m 14'9" arm	5.7 m 18'8" arm	3.4 m 11'2" arm
A Overall Height	6040 mm 19'10"	6460 mm 21'2"	6990 mm 22'11"	6265 mm 20'7"
B Overall Length	16020 mm 52'7"	16050 mm 52'8"	15840 mm 52'0"	14790 mm 48'6"



## WORKING RANGE

Unit: mm ft in

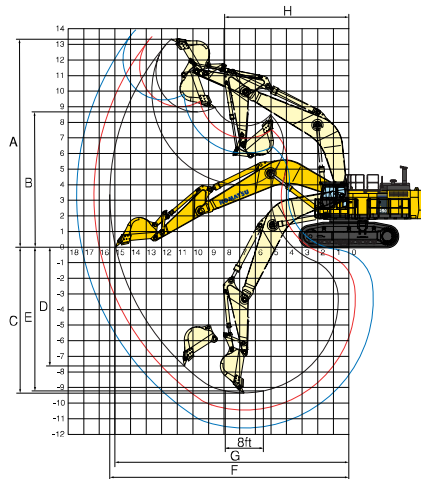

	PC1250-8R			PC1250SP-8R
	9.1 m 29'10" boom			
	3.4 m 11'2" arm	4.5 m 14'9" arm	5.7 m 18'8" arm	3.4 m 11'2" arm
A Max. digging height	13400 mm 44'0"	13490 mm 44'3"	13910 mm 45'8"	13000 mm 42'8"
B Max. dumping height	8680 mm 28'6"	9000 mm 29'6"	9440 mm 31'0"	8450 mm 27'9"
C Max. digging depth	9350 mm 30'8"	10440 mm 34'3"	11590 mm 38'0"	7900 mm 25'11"
D Max. vertical wall digging depth	7610 mm 25'0"	8490 mm 27'10"	9480 mm 31'1"	5025 mm 16'6"
E Max. digging depth of cut for 8' level	9220 mm 30'3"	10340 mm 33'11"	11500 mm 37'9"	7745 mm 25'5"
F Max. digging reach	15350 mm 50'4"	16340 mm 53'7"	17450 mm 57'3"	14070 mm 46'2"
G Max. digging reach at ground level	15000 mm 49'3"	16000 mm 52'6"	17130 mm 56'2"	13670 mm 44'10"
H Min. swing radius	7965 mm 26'2"	7990 mm 26'3"	8150 mm 26'9"	6415 mm 21'1"
Bucket digging force (SAE)	422 kN 43000 kgf / 94,800 lb	422 kN 43000 kgf / 94,800 lb	343 kN 35000 kgf / 77,160 lb	502 kN 51200 kgf / 112,900 lb
Arm crowd force (SAE)	392 kN 40000 kgf / 88,180 lb	327 kN 33300 kgf / 73,410 lb	281 kN 28700 kgf / 63,270 lb	395 kN 40300 kgf / 88,860 lb
Bucket digging force (ISO)	479 kN 48800 kgf / 107,590 lb	479 kN 48800 kgf / 107,590 lb	389 kN 39700 kgf / 87,520 lb	570 kN 58100 kgf / 128,110 lb
Arm crowd force (ISO)	412 kN 42000 kgf / 92,590 lb	337 kN 34400 kgf / 75,840 lb	286 kN 29200 kgf / 64,375 lb	412 kN 42000 kgf / 92,590 lb



## BACKHOE BUCKET, ARM, AND BOOM COMBINATION

BUCKET CAPACITY (HEAPED)				WIDTH				WEIGHT (with side cutters) kg lb		ARM LENGTH m ft in			
SAE, PCSA m³ yd³		CECE m³ yd³		Without Side cutters or shrouds mm in		With Side cutters or shrouds mm in							
PC1250-8 (use with 9.1 m boom)								3.4	11'2"	4.5	14'9"	5.7	18'8"
3.4	4.4	3.0	3.9	1500	59"	1670	65.7"	3550	7,830	—	○	□	
4.0	5.2	3.5	4.6	1710	67.3"	1880	74"	3820	8,420	○	□	▲	
5.0	6.5	4.3	5.6	2050	80.7"	2220	87.4"	4370	9,640	□	▲	—	
5.2	6.8	4.5	5.9	2050	80.7"	2110	83.1"	5780	12,750	□	▲	—	
PC1250SP-8 (use with 7.8 m boom)								3.4	11'2"	—	—	—	
6.7	8.8	5.9	7.7	2280	69.8"	2340	92.1"	6500	14,330	□	—	—	

These charts are based on over-side stability with fully loaded bucket at maximum reach.

○: General purpose use, density up to 2.1 t/m³ 3,500 lb/yd³

□: General purpose use, density up to 1.8 t/m³ 3,000 lb/yd³

▲: General purpose use, density up to 1.5 t/m³ 2,500 lb/yd³

—: Not useable



## LOADING SHOVEL DIMENSIONS

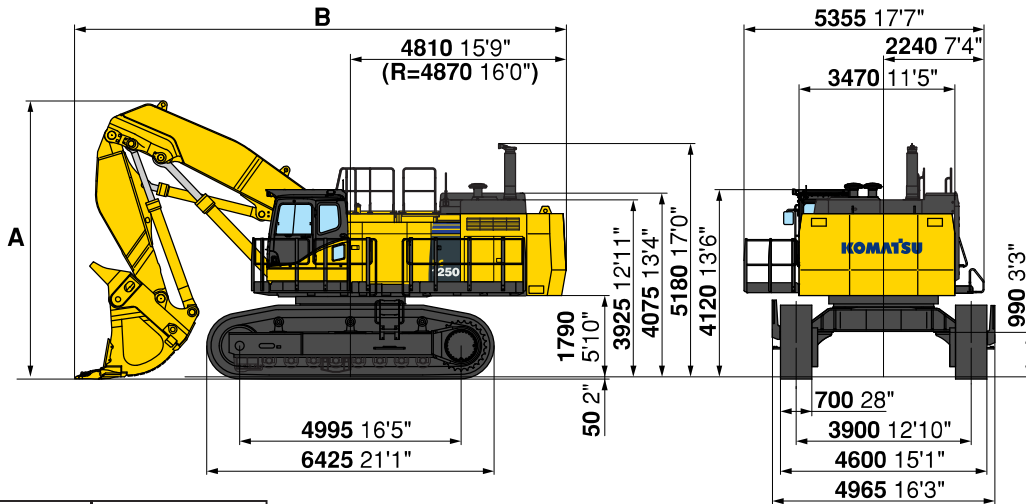

Type of bucket	Bottom dump	
Capacity—heaped	6.5 m <sup>3</sup>	8.5 yd <sup>3</sup>
A Overall Height	6200 mm	20'4"
B Overall Length	10940 mm	35'11"



## LOADING SHOVEL WORKING RANGE AND BUCKET SELECTION

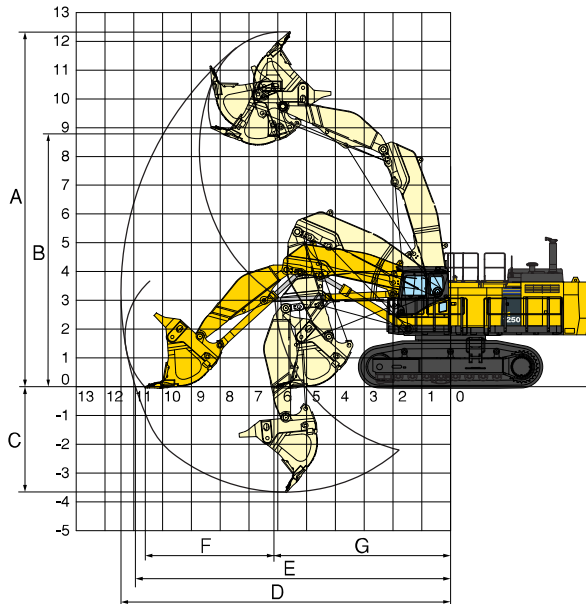

### Working Range

Type of bucket	Bottom dump	
Capacity—heaped	6.5 m <sup>3</sup>	8.5 yd <sup>3</sup>
A Max. cutting height	12330 mm	40'5"
B Max. dumping height	8700 mm	28'7"
C Max. digging depth	3650 mm	12'0"
D Max. digging reach	11400 mm	37'5"
E Max. digging reach at ground level	10900 mm	35'9"
F Level crowding distance	4480 mm	14'8"
G Min. crowd distance	6130 mm	20'1"
Bucket digging force	579 kN 59000 kgf / 130,100 lb	
Arm crowd force	608 kN 62000 kgf / 136,710 lb	

### Bucket Selection

Type of bucket	Bottom dump	
Capacity—heaped	6.5 m <sup>3</sup>	8.5 yd <sup>3</sup>
Width (with side shrouds)	2700 mm	106.3"
Weight	9730 kg	21,450 lb
No. of bucket teeth	6	
Recommended uses	General-purpose digging and loading	



# LIFTING CAPACITY

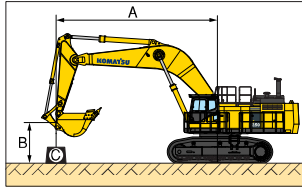

## PC1250-8R

Equipment:

- Boom: **9.1 m 29'10"**
- Arm: **3.4 m 11'2"**
- Bucket: **5.0 m³ 6.5 yd³**
- Bucket weight: **4400 kg 9,700 lb**
- Track shoe width: **700 mm 28"**

A: Reach from swing center

B: Bucket hook height

C: Lifting capacity

Cf: Rating over front

Cs: Rating over side

⊗: Rating at maximum reach

Unit: kg lb

B \ A	⊗ Maximum		12.2 m 40'		10.7 m 35'		9.1 m 30'		7.6 m 25'		6.1 m 20'		4.6 m 15'		
	Cf	Cs	Cf	Cs	Cf	Cs	Cf	Cs	Cf	Cs	Cf	Cs	Cf	Cs	
Heavy Lift On	9.1 m 30'	*15200 *33,500	*15200 *33,500			*18000 *39,700	*18000 *39,700								
	6.1 m 20'	*15950 *35,100	13200 29,100			*20050 *44,200	17400 38,400	*22950 *50,600	*22950 *50,600	*27900 *61,500	*27900 *61,500				
	3.0 m 10'	15650 34,500	11850 26,200	16400 36,100	12500 27,500	20850 46,000	16100 35,500	27000 59,500	20850 46,000	*34950 *77,100	27650 60,900				
	0.0 m 0'	16250 35,900	12300 27,100			19950 44,000	15200 33,500	24200 53,400	18200 40,200	34400 75,800	26100 57,500				
	-3.0 m -10'	19950 44,000	15250 33,600			20000 44,100	15250 33,700	25600 56,400	19550 43,100	34600 76,300	26300 57,900	*43850 *96,700	38400 84,700	*39250 *86,600	*39250 *86,600
	-6.1 m -20'	*23500 *51,800	*23500 *51,800							*25400 *56,100	*25400 *56,100	*32550 *71,800	*32550 *71,800		
Heavy Lift Off	9.1 m 30'	*15200 *33,500	*15200 *33,500			*15500 *34,200	*15500 *34,200								
	6.1 m 20'	*15850 *34,900	13200 29,100			*17300 *38,100	*17300 *38,100	*19950 *44,000	*19950 *44,000	*24400 *53,800	*24400 *53,800				
	3.0 m 10'	15650 34,500	11850 26,200	16400 36,100	12500 27,500	*19800 *43,700	16100 35,500	*23900 *52,700	20850 46,000	*30550 *67,400	27650 60,900				
	0.0 m 0'	16250 35,900	12300 27,100			19950 44,000	15200 33,500	24200 53,400	18200 40,200	*32650 *72,000	26100 57,500				
	-3.0 m -10'	*19600 *43,200	15250 33,600			*19650 *43,300	15250 33,700	*24750 *54,600	19550 43,100	*30750 *67,800	26300 57,900	*38350 *84,500	*38350 *84,500	*39250 *86,600	*39250 *86,600
	-6.1 m -20'	*20150 *44,500	*20150 *44,500							*21900 *48,200	*21900 *48,200	*28150 *62,100	*28150 *62,100		

\* Load is limited by hydraulic capacity rather than tipping. Ratings are based on SAE standard No. J1097. Rated loads do not exceed 87% of hydraulic lift capacity or 75% of tipping load.

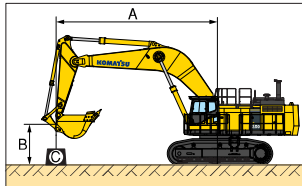

## PC1250-8R

Equipment:

- Boom: **9.1 m 29'10"**
- Arm: **4.5 m 14'9"**
- Bucket: **4.0 m³ 5.2 yd³**
- Bucket weight: **3800 kg 8,380 lb**
- Track shoe width: **700 mm 28"**

A: Reach from swing center

B: Bucket hook height

C: Lifting capacity

Cf: Rating over front

Cs: Rating over side

⊗: Rating at maximum reach

Unit: kg lb

B \ A	⊗ Maximum		12.2 m 40'		10.7 m 35'		9.1 m 30'		7.6 m 25'		6.1 m 20'		4.6 m 15'		
	Cf	Cs	Cf	Cs	Cf	Cs	Cf	Cs	Cf	Cs	Cf	Cs	Cf	Cs	
Heavy Lift On	9.1 m 30'	*9300 *20,500	*9300 *20,500												
	6.1 m 20'	*9650 *21,300	*9650 *21,300	*16650 *36,700	13700 30,200	*18150 *40,000	18000 39,700	*20550 *45,400	*20550 *45,400						
	3.0 m 10'	*10950 *24,200	10200 22,500	16650 36,700	12750 28,100	21200 46,700	16400 36,100	*25600 *56,500	21300 47,000	*32350 *71,400	28500 62,800				
	0.0 m 0'	*13650 *30,100	10400 23,000	15850 34,900	11950 26,400	19900 43,900	15150 33,400	24550 54,100	18500 40,800	34,450 75,900	26100 57,600	*29300 *64,600	*29300 *64,600		
	-3.0 m -10'	16400 36,200	12400 27,300			19550 43,100	14800 32,600	25100 55,400	19050 42,000	34000 75,000	25700 56,600	*46350 *102,200	37500 82,600	*31900 *70,300	*31900 *70,300
	-6.1 m -20'	*21750 *48,000	18700 41,300					*23650 *52,100	20000 44,100	*28850 *63,600	25200 55,500	*38200 *84,300	*38200 *84,300	*48900 *107,800	*48900 *107,800
Heavy Lift Off	9.1 m 30'	*9300 *20,500	*9300 *20,500												
	6.1 m 20'	*9650 *21,300	*9650 *21,300	*14250 *31,400	13700 30,200	*15600 *34,400	*15600 *34,400	*17850 *39,300	*17850 *39,300						
	3.0 m 10'	*10950 *24,200	10200 22,500	*16050 *35,400	12750 28,100	*18500 *40,800	16400 36,100	*22250 *49,000	21300 47,000	*28250 *62,300	*28250 *62,300				
	0.0 m 0'	*13650 *30,100	10400 23,000	15850 34,900	11950 26,400	19900 43,900	15150 33,400	*24200 *53,300	18500 40,800	*31950 *70,400	26100 57,600	*29300 *64,600	*29300 *64,600		
	-3.0 m -10'	16400 36,200	12400 27,300			19550 43,100	14800 32,600	25100 55,400	19050 42,000	*31650 *69,800	25700 56,600	*40550 *89,400	37500 82,600	*31900 *70,300	*31900 *70,300
	-6.1 m -20'	*18650 *41,100	18650 41,100					*20300 *44,800	20000 44,100	*24800 *54,700	24800 54,700	*33200 *73,200	*33200 *73,200	*42600 *93,900	*42600 *93,900

\* Load is limited by hydraulic capacity rather than tipping. Ratings are based on SAE standard No. J1097. Rated loads do not exceed 87% of hydraulic lift capacity or 75% of tipping load.



# LIFTING CAPACITY

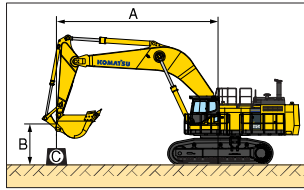

## PC1250-8R

Equipment:

- Boom: **9.1 m 29'10"**
- Arm: **5.7 m 18'8"**
- Bucket: **3.4 m³ 4.4 yd³**
- Bucket weight: **3600 kg 7,940 lb**
- Track shoe width: **700 mm 28"**

- A: Reach from swing center
- B: Bucket hook height
- C: Lifting capacity
- Cf: Rating over front
- Cs: Rating over side
- ☉: Rating at maximum reach

Unit: kg lb

B \ A	☉ Maximum		13.7 m 45'		12.2 m 40'		10.7 m 35'		9.1 m 30'		7.6 m 25'		6.1 m 20'		
	Cf	Cs	Cf	Cs	Cf	Cs	Cf	Cs	Cf	Cs	Cf	Cs	Cf	Cs	
Heavy Lift On	9.1 m 30'	*5900 *13,000	*5900 *13,000												
	6.1 m 20'	*6050 *13,400	*6050 *13,400	*11050 *24,300	10950 24,100	*14950 *32,900	14350 31,600								
	3.0 m 10'	*6800 *15,000	*6800 *15,000	13550 29,900	10250 22,600	17050 37,600	13100 28,900	*19800 *43,700	16900 37,200	*23450 *51,700	22050 48,600	*29300 *64,600	*29300 *64,600	*39750 *87,600	*39750 *87,600
	0.0 m 0'	*8400 *18,500	*8400 *18,500	12850 28,400	9600 21,100	15950 35,200	12050 26,600	20,100 44,300	15300 33,800	25900 57,100	19800 43,600	34800 76,700	26450 58,300	*31200 *68,800	*31200 *68,800
	-3.0 m -10'	*11500 *25,400	*10150 22,400			15500 34,100	11600 25,600	19300 42,600	14600 32,100	24850 54,800	18800 41,500	33600 74,100	25300 55,800	*47600 *105,000	*36800 81,100
	-6.1 m -20'	18600 41,000	14100 31,100					19750 43,500	15000 33,000	25200 55,600	19150 42,200	*33250 *73,300	25850 56,900	*42350 *93,300	37850 83,400
Heavy Lift Off	9.1 m 30'	*5900 *13000	*5900 *13000												
	6.1 m 20'	*6050 *13,400	*6050 *13,400	*11050 *24,300	10950 24,100	*12700 *28,000	*12700 *28,000								
	3.0 m 10'	*6800 *15,000	*6800 *15,000	*13350 *29,500	10250 22,600	*14850 *32,800	13100 28,900	*17050 *37,600	16900 37,200	*20300 *44,800	*20300 *44,800	*25550 *56,300	*25550 *56,300	*34850 *76,800	*34850 *76,800
	0.0 m 0'	*8400 *18,500	*8400 *18,500	12850 28,400	9600 21,100	15950 35,200	12050 26,600	*19700 *43,400	15300 33,800	*24000 *53,000	19800 43,600	*30600 *67,500	26450 58,300	*31200 *68,800	*31200 *68,800
	-3.0 m -10'	*11500 *25,400	*10150 22,400			15500 34,100	11600 25,600	19300 42,600	14600 32,100	24850 54,800	18800 41,500	*31900 *70,300	25300 55,800	*41650 *91,800	36600 81,100
	-6.1 m -20'	*16550 *36,500	14100 31,100					*18050 *39,800	15000 33,000	*22950 *50,600	19150 42,200	*28850 *63,600	25850 56,900	*36900 *81,300	*36900 *81,300

\* Load is limited by hydraulic capacity rather than tipping. Ratings are based on SAE standard No. J1097. Rated loads do not exceed 87% of hydraulic lift capacity or 75% of tipping load.

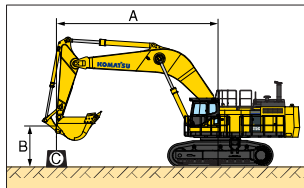

## PC1250SP-8R

Equipment:

- Boom: **7.8 m 25'7"**
- Arm: **3.4 m 11'2"**
- Bucket: **6.7 m³ 8.8 yd³**
- Bucket weight: **6300 kg 13,890 lb**
- Track shoe width: **700 mm 28"**

- A: Reach from swing center
- B: Bucket hook height
- C: Lifting capacity
- Cf: Rating over front
- Cs: Rating over side
- ☉: Rating at maximum reach

Unit: kg lb

B \ A	☉ Maximum		12.2 m 40'		10.7 m 35'		9.1 m 30'		7.6 m 25'		6.1 m 20'		4.6 m 15'		
	Cf	Cs	Cf	Cs	Cf	Cs	Cf	Cs	Cf	Cs	Cf	Cs	Cf	Cs	
Heavy Lift On	9.1 m 30'	*11700 *25,800	*11700 *25,800				*17050 *37,600	*17050 *37,600							
	6.1 m 20'	*12250 *27,000	*12250 *27,000			*16300 *35,900	16100 35,600	*24350 *53,700	22600 49,800	*28750 *63,400	*28750 *63,400	*36350 *80,100	*36350 *80,100		
	3.0 m 10'	*14600 *32,200	13700 30,200			20150 44,400	15300 33,800	26950 59,500	20750 45,700	*33850 *74,700	27000 59,600	*47450 *104,600	41150 90,700		
	0.0 m 0'	19300 42,600	14550 32,000			19400 42,800	14600 32,200	25600 56,400	19450 42,900	31750 70,000	23500 51,800	*48750 *107,500	38650 85,200		
	-3.0 m -10'	*23900 *52,700	19550 43,100					*23950 *52,900	19550 43,100	*30750 *67,800	24850 54,800	*41450 *91,300	39,250 86,500	*52450 *115,700	*52450 *115,700
	-6.1 m -20'														
Heavy Lift Off	9.1 m 30'	*11700 *25,800	*11700 *25,800				*17050 *37,600	*17050 *37,600							
	6.1 m 20'	*12250 *27,000	*12250 *27,000			*16300 *35,900	16100 35,600	*21150 *46,600	*21150 *46,600	*25150 *55,500	*25150 *55,500	*32100 *70,800	*32100 *70,800		
	3.0 m 10'	*14600 *32,200	13700 30,200			20150 44,400	15300 33,800	*24450 *54,000	20750 45,700	*29450 *65,000	27000 59,600	*41750 *92,000	41150 90,700		
	0.0 m 0'	19300 42,600	14550 32,000			19400 42,800	14600 32,200	25600 56,400	19450 42,900	*29900 *65,900	23500 51,800	*42750 *94,300	38650 85,200		
	-3.0 m -10'	*20500 *45,200	19550 43,100					*20550 *45,300	19550 43,100	*26450 *58,300	24850 54,800	*36100 *79,600	*36100 *79,600	*45800 100,800	*45800 100,800
	-6.1 m -20'														

\* Load is limited by hydraulic capacity rather than tipping. Ratings are based on SAE standard No. J1097. Rated loads do not exceed 87% of hydraulic lift capacity or 75% of tipping load.





Transportation volume (length x height x width)

Specs shown include the following equipment:

**Backhoe:** boom **9100 mm** 29'10", arm **3400 mm** 11'2", bucket **5.0 m<sup>3</sup>** 6.5 yd<sup>3</sup>, shoes **700 mm** 28" double grouser

**Work equipment assembly (Backhoe)**

Weight : PC1250-8R : **25.3t** 27.9U.S.ton  
PC1250SP-8R : **27.7t** 30.5U.S.ton

**Boom**



PC1250-8R : **11.2t : 9475 x 2894 x 1474**  
12.3U.S.ton : 31'1" x 9'6" x 4'10"  
PC1250SP-8R : **11.1t : 8170 x 3095 x 1474**  
12.2U.S.ton : 26'10" x 10'2" x 4'10"

**Arm**

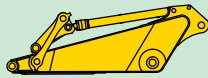

PC1250-8R : **5.9t : 4895 x 1626 x 890**  
6.5U.S.ton : 16'1" x 5'4" x 2'11"  
**6.2t : 4895 x 1626 x 890**(Heavy-duty version)  
6.8U.S.ton : 16'1" x 5'4" x 2'11"  
PC1250SP-8R : **6.4t : 4914 x 1683 x 890**  
7.1U.S.ton : 16'1" x 5'6" x 2'11"

**Bucket**

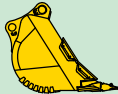

PC1250-8R : **4.3t : 2700 x 2100 x 2050**  
4.7U.S.ton : 8'10" x 6'11" x 6'9"  
**5.5t : 2580 x 2276 x 2250**(Heavy-duty version)  
6.1U.S.ton : 8'6" x 7'6" x 7'5"  
PC1250SP-8R : **6.3t : 2527 x 2420 x 2520**  
6.9U.S.ton : 8'3" x 7'11" x 8'3"

**Arm cylinder**



Length : **3950** 13'0"

**1.5t**  
1.7U.S.ton

**Boom cylinder**

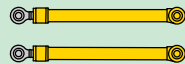

Length: **3810** 12'6"

**2.4t [1.2t x 2]**  
2.64U.S.ton [1.32U.S.ton x 2]

**Upper structure**

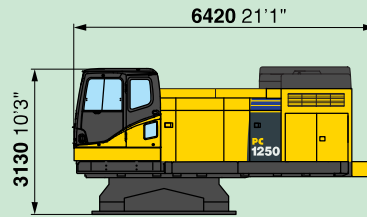

Width : **3490** 11'5"  
Weight : **36.4t** 40.1U.S.ton

**Undercarriage**

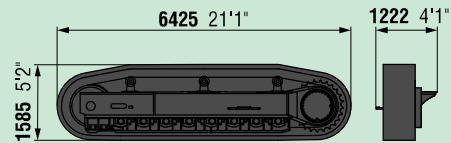

Weight : **30t [15t x 2]**  
33.1U.S.ton [16.55U.S.ton x 2]  
Weight : **30.9t [15.45t x 2]**(with full length roller guard)  
34.1U.S.ton [17.05U.S.ton x 2]

**Others**

Weight : **18.4t** 20.3U.S.ton

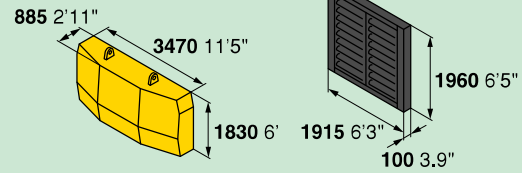

Weight : **18.0t** 19.8U.S.ton

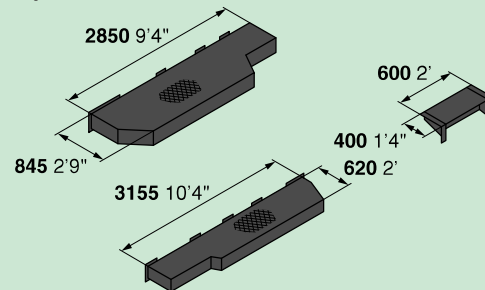



## STANDARD EQUIPMENT

### ENGINE AND RELATED ITEMS:

- Air cleaner, double element, dry
- Variable speed cooling fan, with fan guard
- Engine, Komatsu SAA6D170E-5

### ELECTRICAL SYSTEM:

- Alternator, 60 amp, 24 V
- Batteries, 220 Ah, 2 x 12 V
- Starting motors, 11kW x 2
- Working lights-2 boom, 2 cab top front, 1 machine cab bottom, 1 cab LH(Step light with timer)
- Auto decelerator

### UNDERCARRIAGE:

- 700 mm 28" double grouser
- 8 track/3 carrier rollers (each side)
- Hydraulic track adjusters (each side)
- Track guiding guard (each side)

### GUARDS AND COVERS:

- Dust-proof net for radiator and oil cooler
- Pump/engine room partition wall
- Travel motor guards
- Revolving frame under cover (Heavy-duty)

### OPERATOR ENVIRONMENT:

- Damper mount, all-weather, sound-suppressed cab with tinted safety glass windows, lockable door, intermittent window wiper and washer, floor mat, cigarette lighter and ashtray
- Instrument panel with electronic display/monitor system, electronically-controlled throttle dial, electric service meter, gauges (coolant temperature, hydraulic temperature and fuel level), caution lights (electric charge, engine oil pressure, and air cleaner clogging), indicator lights (engine preheating and swing lock light) level check lights (coolant, engine oil, and hydraulic oil level), self-diagnostic system with trouble data memory
- Rearview mirrors, left and right
- Seat, fully adjustable with suspension
- Cab with fixed front window



## OPTIONAL EQUIPMENT

- Alternator, 90 Amp, 24 V
- Arms (Backhoe):
  - 3400mm 11'2" arm assembly
  - 3400mm 11'2" HD arm assembly
  - 3400mm 11'2" SP arm assembly
  - 4500mm 14'9" arm assembly
  - 4500mm 14'9" HD arm assembly
  - 5700mm 18'8" arm assembly
- Arms (Loading shovel):
  - 3800mm 12'6" arm assembly
- Auto air conditioner
- Automatic grease system, Lincoln 18 ltr
- Booms (Backhoe):
  - 7800mm 25'7" SP boom assembly
  - 9100mm 29'10" boom assembly
- Booms (Loading shovel):
  - 5300mm 17'5" boom assembly

### HYDRAULIC CONTROLS:

- Fully hydraulic, with Electronic Open-Center Load-Sensing (EOLSS) and engine speed sensing (pump and engine mutual control system)
- One gear pump for control circuit
- Two axial piston motors for swing with single-stage relief valve
- One axial piston motor per track for travel with counter balance valve
- Three variable capacity piston pumps
- Three control valves, 5+4+4 spools (boom, arm, bucket, swing, and travel)
- Control levers, wrist control levers for arm, boom, bucket, and swing with PPC system
- Control levers and pedals for steering and travel with PPC system
- Oil cooler
- In-line high pressure filters
- Shockless boom control
- Two-mode setting for boom

### DRIVE AND BRAKE SYSTEM:

- Brakes, hydraulic lock travel brakes, oil disc parking
- Hydrostatic two travel speed system with planetary double reduction final drive

### OTHER STANDARD EQUIPMENT:

- Automatic swing holding brake
- Corrosion resister
- Counterweight, 18000 kg 39,680 lb
- Horn, air
- Marks and plates, English
- Paint, Komatsu standard
- Vandalism protection locks
- Wide catwalk
- Large handrails
- One-touch engine oil drainage
- PM tune-up service connector
- Travel alarm
- Rear reflector
- Slip-resistant plates

- Cab with pull-up type front window
- Communication system for VHMS (Orbcomm)
- General tool kit
- Grease gun, air pump
- Heater
- Interconnected horn and flashing light
- Radio AM/FM
- Seat belt 78 mm 3"
- Shoes:
  - 1000 mm 39.4" double grouser
- Spare parts for first service
- Track roller guard (full length)
- Track frame undercover (center)
- Vehicle Health Monitoring System (VHMS)

M E M O

A series of horizontal dashed lines for writing.

